

AQL-933-F150

150W Floodlight

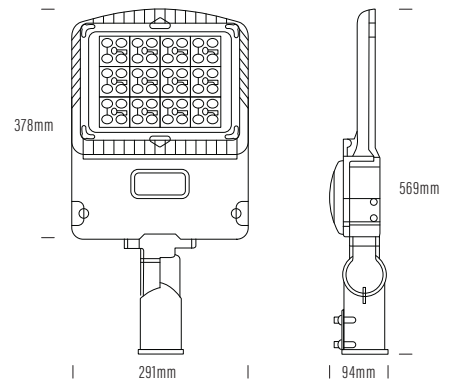

Model	AQL-933-F150
Input Voltage	AC100-277V, 47-63Hz
Power	150W
Power Factor	>0.96
Power efficiency	>90%
Lumens	25,500lm
Lumen Efficiency	170lm/W
CRI	Ra>70
CCT	3000K - 5700K
Beam Angles	30° / 60° / 90° / Type 2M / 3M / 4M
Life Span	50000 hours, @25°C
Construction Material	Aluminum
Lens Material	PC
LED Driver	Inventronics EUM Series
LED Chip	SMD5050
Net Weight	6kg

150W Floodlight

Bracket Options

Mounting Bracket - 4 options available

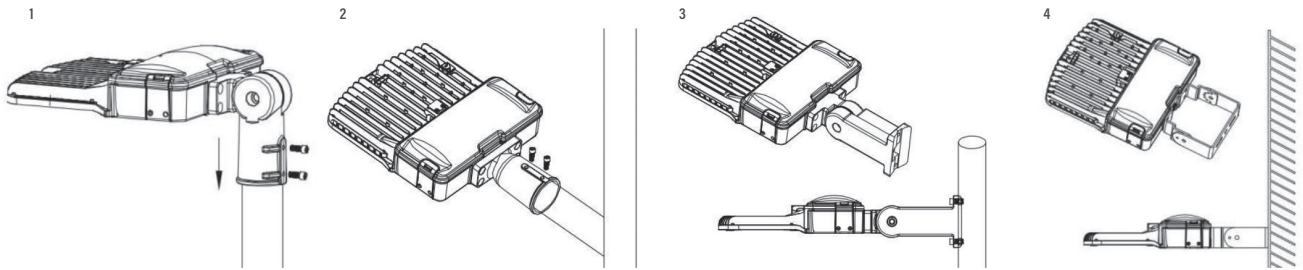

Accessories

Mounting Brackets

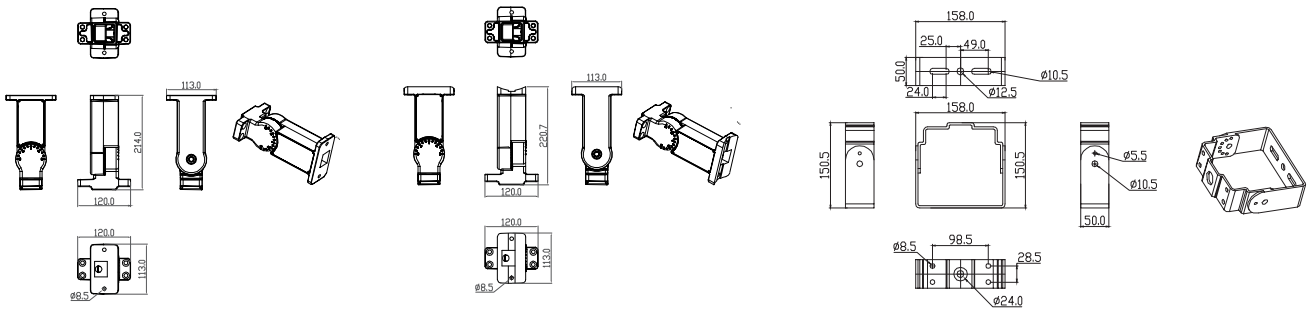

150W Floodlight

Charts

Photometric Charts

Illumination Guide

T2

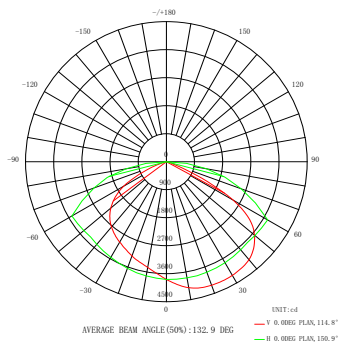

T3

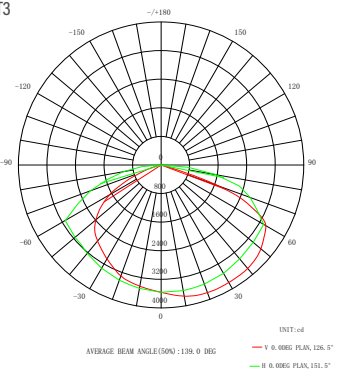

T4

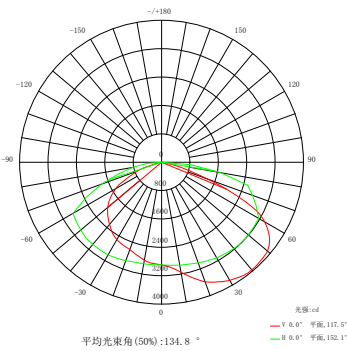

T3

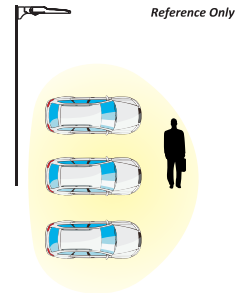

T4

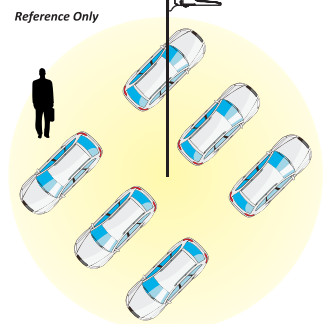

150W Floodlight

Pole Options

R45-60 / 4.5M 60mm spigot

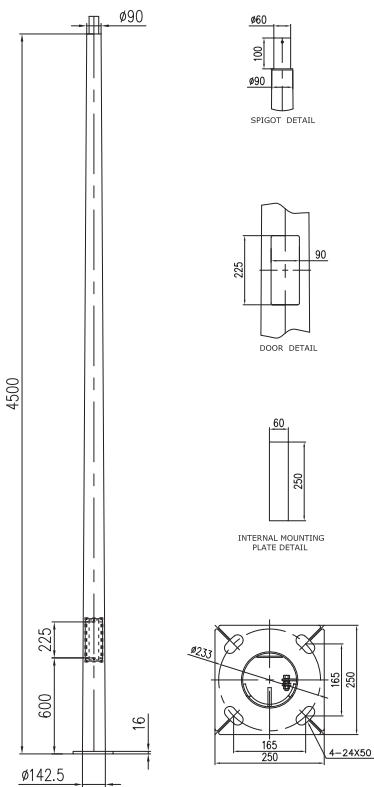

R6-60 / 6.0M 60mm spigot

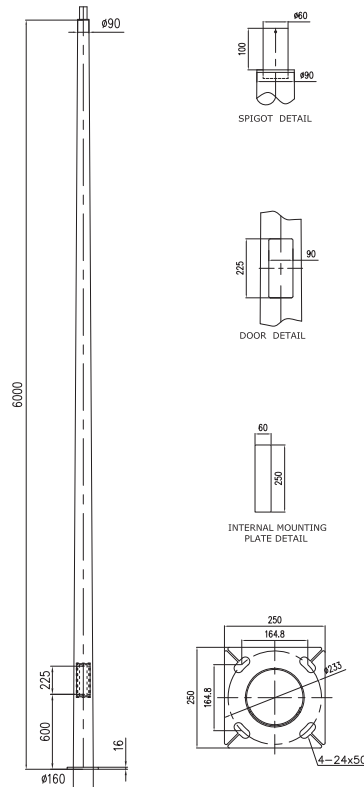

R8-60 / 8.0M 60mm spigot

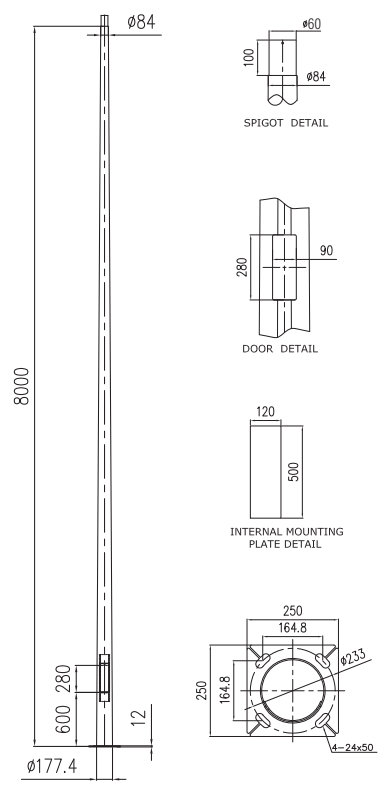

Pile Foundation Guide

Notes:

1. This table is to be used as a guide only. All pile specifications should be confirmed with an appropriately qualified engineer prior to construction.
2. All workmanship and materials shall be in accordance with the current SAA code AS3600 Concrete structures, and AS 2159 Piling - Design and installation with amendments.
3. All concrete to have a minimum characteristic strength of 32MPa or 40MPa where an exposure classification of Moderate is determined in accordance with AS2159 Piling-Design and installation.
4. Minimum clear concrete cover to be 65mm.
5. All concrete shall be place and vibrated to optimum compaction.
6. Pile casings to be used for constructions purposes where required.
7. Engineering advice is to be sort where soils are assessed to be of exposure classifications severe or greater as determined in accordance with AS2159 Piling-Design and installation.
8. Soil classification to be determined by a geotechnical engineer.

