

Aqualux Non-Dimmable IP67 Power Supplies

Technical Datasheet



Features

- Wide input voltage 85 - 265VAC
- Complete isolation design for safer operation
- IP67 suitable for indoor & outdoor use - indoor DO NOT COVER
- Flicker Free Design
- Short circuit, over-current & over-voltage protection
- Active power correction with high power factor
- 5-year warranty

Part Numbers

- AQD-WPS-030-24-N
- AQD-WPS-060-24-N
- AQD-WPS-120-24-N
- AQD-WPS-250-24-N

Technical Parameters

Model		AQD-WPS-030-24-N	AQD-WPS-060-24-N	AQD-WPS-1200-24-N	AQD-WPS-250-24-N
Output	Voltage	24V	24V	24V	24V
	Current	1.25A (Max)	2.5A (Max)	5A (Max)	10.42A (Max)
	Power	30W	60W	120W	250W
	Ripple & Noise (max)	200mV	200mV	200mV	200mV
	Channel	1	1	1	1
	Voltage Tolerance	3%	3%	3%	3%

Model	AQD-WPS-030-24-N	AQD-WPS-060-24-N	AQD-WPS-1200-24-N	AQD-WPS-250-24-N
Input	Input Voltage	85-265VAC	85-265VAC	85-265VAC
	Frequency	50/60Hz	50/60Hz	50/60Hz
	Power Factor	>0.95	>0.95	>0.95
	THD	<10%	<10%	<10%
	Standby Power	0.5W	0.5W	0.5W
	Current	0.35A	0.7A	1.4A
	Inrush Current	<75A	<75A	<75A
	Efficiency Full Load 110VAC	85%	85%	86%
	Efficiency Full Load 230VAC	87%	88%	88%
	Start 230VAC (milliseconds)	<1000	<1000	<1000
	Rise Time 230VAC (milliseconds)	<50mS	<50mS	<50mS
Hold Time 230VAC (milliseconds)	>17	>17	>17	
Dimensions	Product Dimensions	160*44*32mm	164*56*35mm	186*68*39mm
	Individual Box Dimensions	200*85*50mm	200*85*50mm	270*90*50mm
	Product Weight	500G	640G	914G
	Carton Dimensions	415*270*190mm	415*270*190mm	415*270*190mm
	Carton QTY	20	20	14
	Carton Weight	10.7KG	13.5KG	13.5KG
Protection	Short Circuit	Yes	Yes	Yes
	Over Voltage	Yes	Yes	Yes
	Over Load	Yes	Yes	Yes
Safety & EMC	Lighting Strike	L-N 6KV L-PE 10KV N-PE 10KV		
	Withstand Voltage	I/P-O/P:3750VAC/5mA I/P-PG:1554VAC/5mA O/P-PG:1554VAC/5mA		
	Safety Standards	IEC 61347-2-13:2014+A1:2016 IEC 61347-2-13:2014+A1:2016 used in conjunction with IEC 61347-1:2015+A1:2017		
	EMC Emission EMC	EN50515,EN61000-3-2 Class C,IEC61000-3-3		
	EMC Immunity EMC	EN61000-4-2,3,4,5,6,8,11 EN61547,GB17625.1		
	Safety Approval Mark	RCM / GMA-520963		
Environment	Working Temperature	(-20°C~40°C)	(-20°C~40°C)	(-20°C~40°C)
	Storage Temperature	(-20°C~80°C)	(-20°C~80°C)	(-20°C~80°C)
	TC	TC 75	TC 75	TC 75
	Housing Material	aluminum	aluminum	aluminum
	IP Rating	IP67	IP67	IP67
	Lifetime	30000H	30000H	30000H
	Switch Cycle	>25,000	>25,000	>25,000

Notes

1. Unless otherwise specified, all specifications and parameters shall be measured at the input of 230VAC, rated load and ambient temperature of 25°C.
2. Ripple and noise measurement method: A12" twisted-pair line with 0.1uF and 47uF capacitors in parallel should be used for measurement under 20MHZ bandwidth.
3. The start time is measured under the starting of the cold machine. Frequent switching on and off may increase the start time.
4. The driver is regarded as a component used in combination with the terminal equipment. Since the EMC is affected by the whole device, the manufacturer of the terminal equipment needs to reconfirm the EMC of the whole device.

Product Dimensions

AQD-WPS-030-24-N

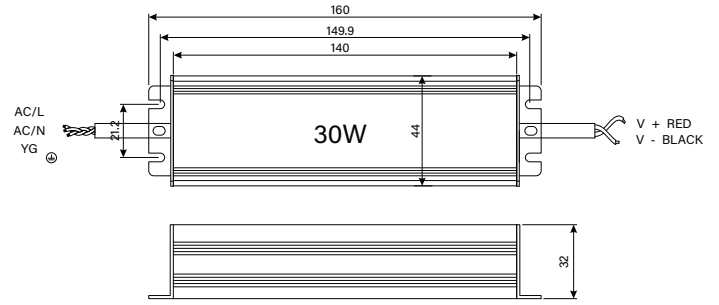

AQD-WPS-060-24-N

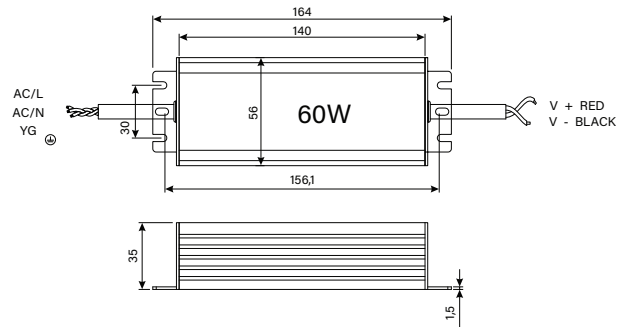

AQD-WPS-120-24-N

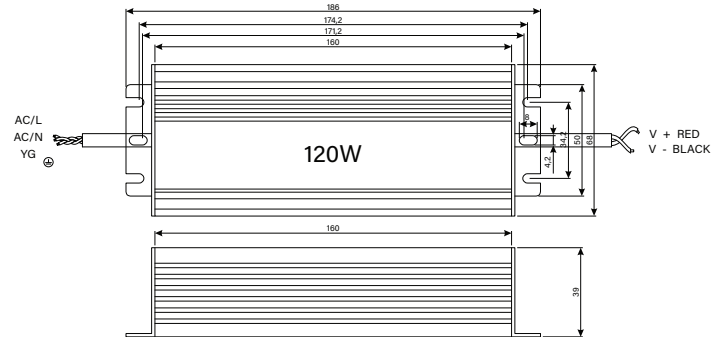

AQD-WPS-250-24-N

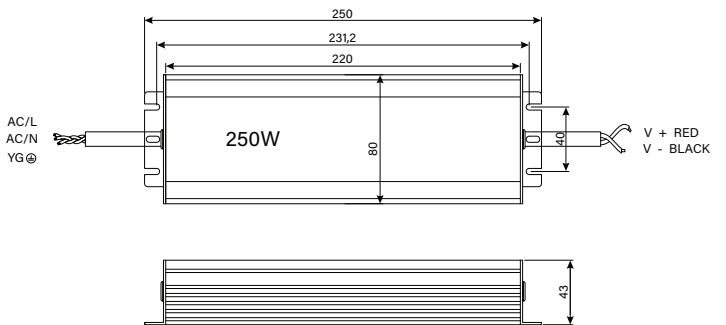

Wiring

24VDC Constant Voltage. Wiring must be in parallel.

✔ **Correct Parallel Wiring**

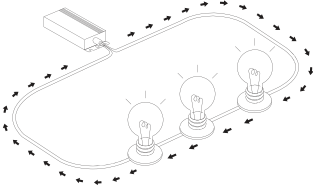

✘ **Wrong Series Wiring**

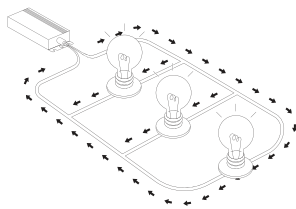

Product Notes

- This product must be installed and used as per its specifications.
- This product contains no serviceable parts and no attempt should be made to repair it. If the product is faulty it should be discarded.
- This product is not suitable for installation in hazardous and/or corrosive areas.
- Electrical installations periodically receive transient over-voltages. This product has been designed to minimize the effect of such voltages on connected equipment. It may not give full protection for extreme over-voltage transients such as those resulting from a close lightning strike.

Temperature Derating Curve

