

AQS-510 / Mono

AQS-510 is a high output top-view IP68 Neon Flex in variety of CCT variations for external facade illumination, pool copings, in-pavement channels and exterior wall grazing where substantial moisture and mechanical protection is required.

Neon Flex

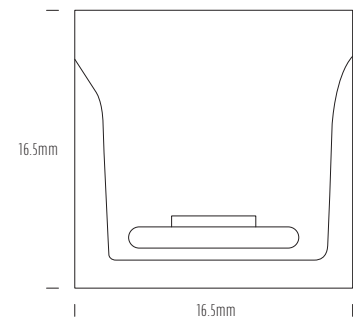
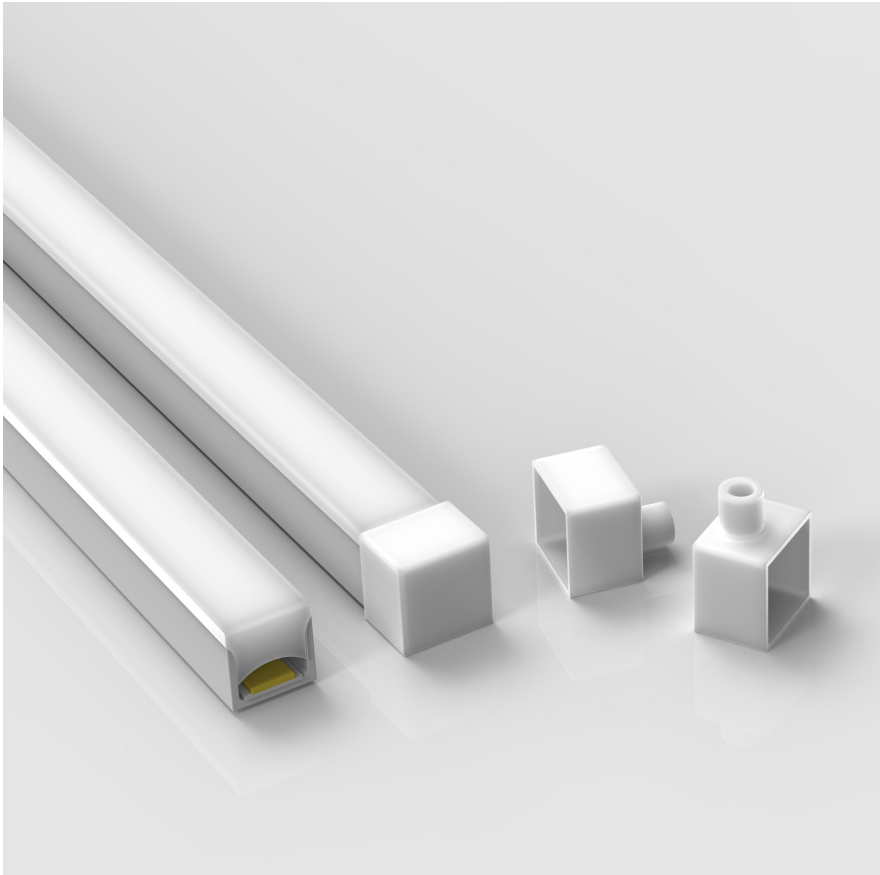

Product	AQS-510-Mono
Voltage	24V DC
Watts (per Meter)	10W
IP Rating	IP68
Lumen Output (per Meter)	TBA
CCT & Colour Options	2200K to 6500K / R / G / B / Amber / Pink / Orange
Working Mode	Constant Voltage (PWM)
Max Length (Single Power Feed)	10m
Max Length (Double Power Feed)	20m
Cut Interval	83.30mm
Bend Direction	Vertically
Minimum Bend Diameter	120mm
LED Type	SMD3528
LED Qty / M	144pcs
Lumen Maintenance	70,000 Hours L70@ 25°C, 50,000 Hours L70@ 50°C
Materials	Eco PVC
Emission Angle	120°
Operating Temperature	-20° to +40°C
Installation Temperature	5° to +35°C
Warranty	3 Years

Production Tolerances

The AQS-500 series Neon Flex product is manufactured in a continuous extrusion process and then manually terminated with IP68 overmolded cable entry points. Production tolerances need to be accounted for during site preparation.

- < 1M ±5mm
- < 5M Length ±10mm
- < 10M Length ±15mm
- < 20M ± 20mm

Refer to installation guide when planning your project.

For wiring diagrams please refer to the aqualux website: www.aqualux.com.au / Support / Downloads / Wiring Diagrams

As with all IP68 products, the ingress protection is determined by the quality of the cable joints and installation.

Neon Flex

Variations

Product	CCT Kelvin	Voltage Direct Current	Watts Meter	Lumens Meter	Min Run Single End	Max Run Double End
AQS-510-RDA10	RED	24V DC	10W	109lm	10m	20m
AQS-510-GNA10	GREEN	24V DC	10W	338lm	10m	20m
AQS-510-BUA10	BLUE	24V DC	10W	53lm	10m	20m
AQS-510-AMA10	AMBER	24V DC	10W	110lm	10m	20m
AQS-510-ORA10	ORANGE	24V DC	10W	292lm	10m	20m
AQS-510-PKA10	PINK	24V DC	10W	178lm	10m	20m
AQS-510-22A10	2200K	24V DC	10W	358lm	10m	20m
AQS-510-27A10	2700K	24V DC	10W	459lm	10m	20m
AQS-510-30A10	3000K	24V DC	10W	450lm	10m	20m
AQS-510-35A10	3500K	24V DC	10W	414lm	10m	20m
AQS-510-40A10	4000K	24V DC	10W	460lm	10m	20m
AQS-510-45A10	4500K	24V DC	10W	484lm	10m	20m
AQS-510-50A10	5000K	24V DC	10W	540lm	10m	20m
AQS-510-65A10	6500K	24V DC	10W	521lm	10m	20m

Bending Directions

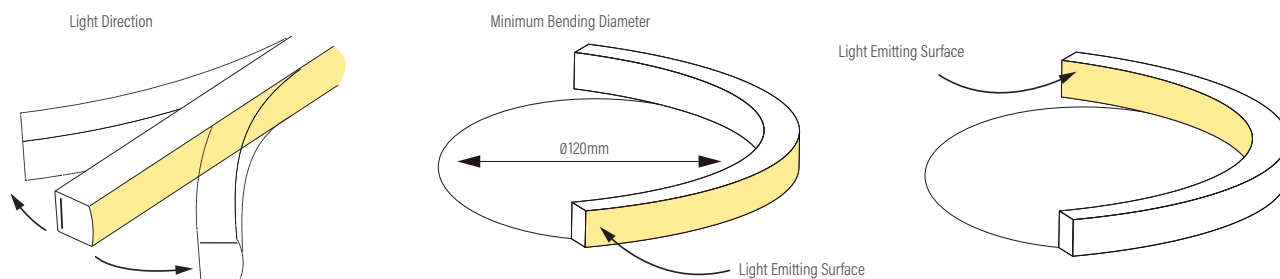

DMX Cable Length Limits

Without Amplification Total Length = 50m

With Single Amplification Total Length = 100m

With Dual Amplification Total Length = 200m

Quick Connect Cable Entry Options

- Integrated non-removeable anti-siphon device
- IP68 factory assembly only
- Injection Moulded Connectors

Direct Cable Entry

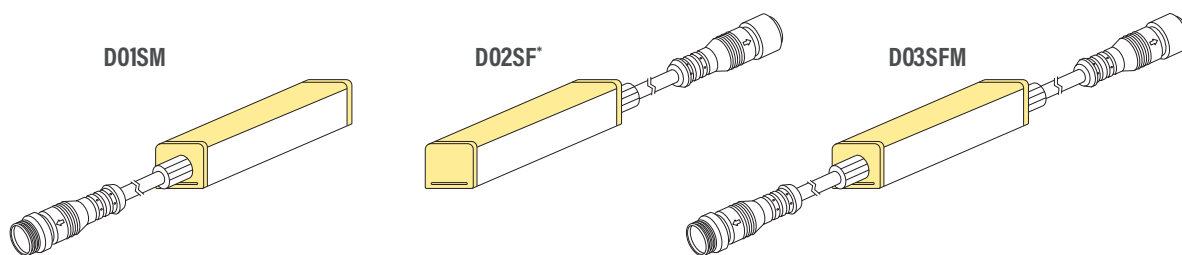

*For use in DMX / SPI signal flow direction.

Side Cable Entry

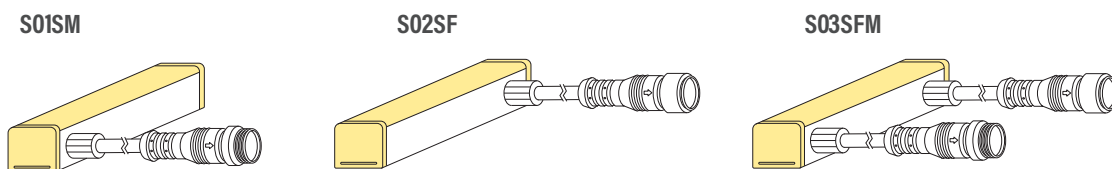

Bottom Cable Entry

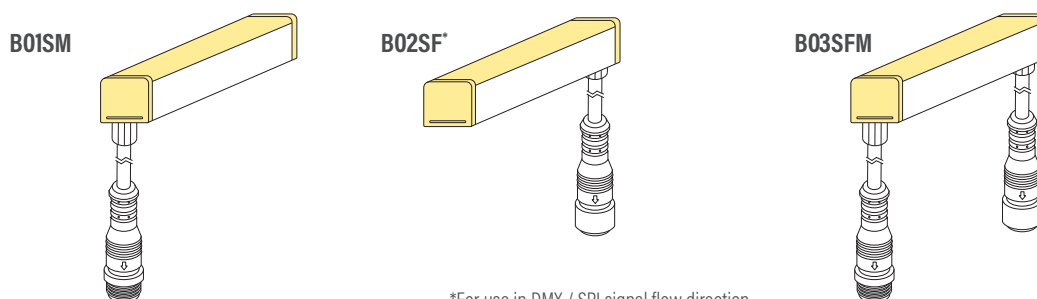

*For use in DMX / SPI signal flow direction.

Neon Flex

Quick Connector Dimensions

Direct Cable Entry

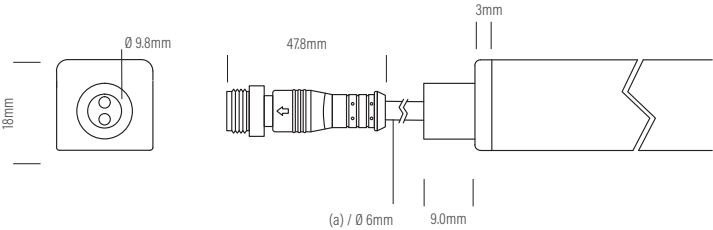

(a) = Minimum length of 6 - 8mm

Side Cable Entry

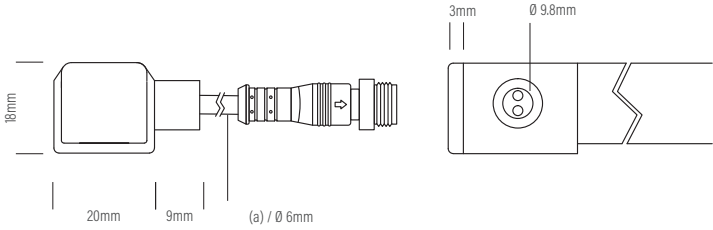

(a) = Minimum length of 6 - 8mm

Bottom Cable Entry

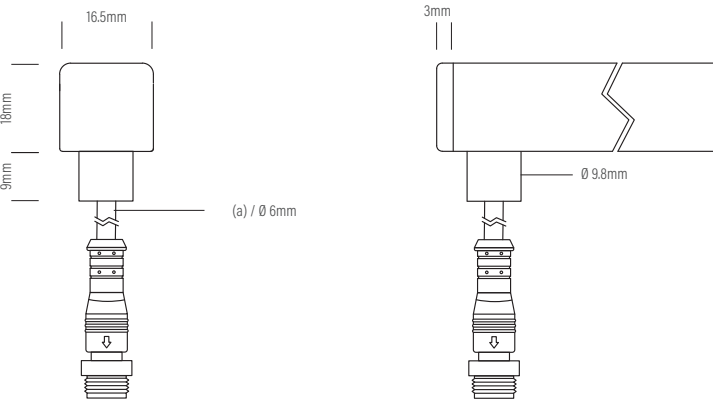

(a) = Minimum length of 6 - 8mm

Neon Flex

Extrusion and End Cap allowances

Assembly Notes

Quick Connector Output

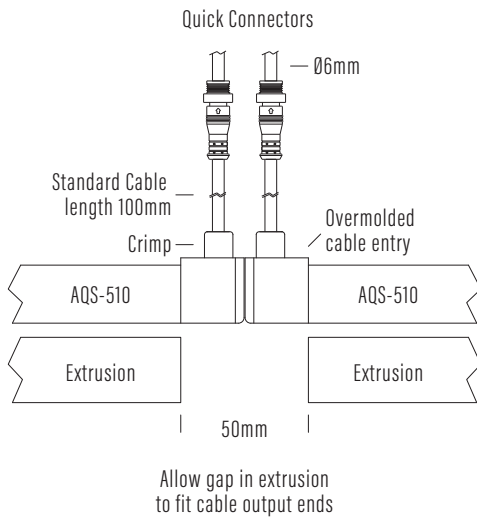

Quick Connector Output

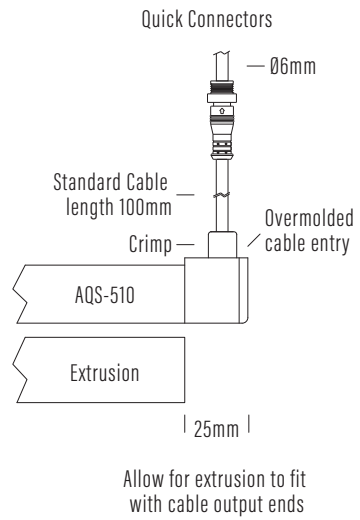

Neon Flex

Mounting

AQS-510-ACC-01
Aluminium Clip

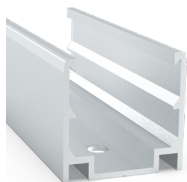
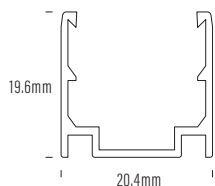

AQS-510-ACC-02
Aluminium Clip

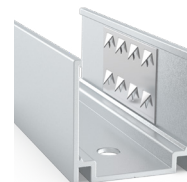
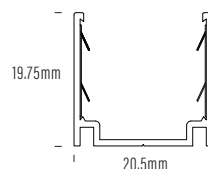

AQS-510-ACC-AL-01
1m Aluminium

Anti-slip profile.

1. More aggressive retention of Neon Flex.
2. Harder to remove once inserted.
3. Use for vertical or inverted mounting applications.

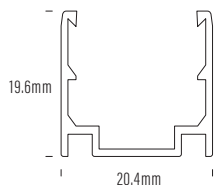

AQS-510-ACC-AL-02
2m Aluminium

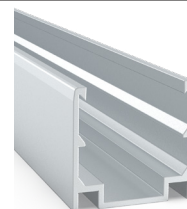
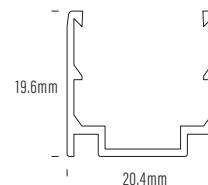

AQS-510-ACC-AL2-02
2m Aluminium

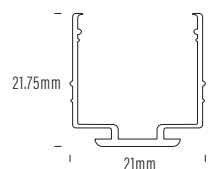

AQS-510-ACC-AL-03
1m Polycarbonate

Standard profile.

1. Use for horizontal applications.
2. Easier to remove Neon Flex once inserted.

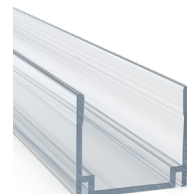
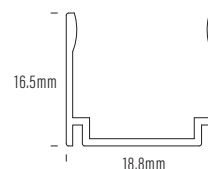

AQS-510-ACC-01-SS
316SS Mounting Clip

Application.

1. Pools and High Corrosive areas.

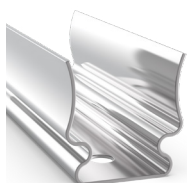
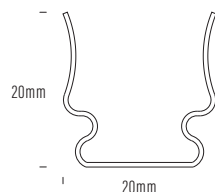

Neon Flex

AQS Family Reference Table

Product	Type	IP Rating	LED Options	Size mm	Power/m	Application
AQS-170	Cob Strip	IP20	Mono	10mm	5W / 10W / 15W DC	Internal / Profile required
AQS-172	Cob Strip	IP20	Mono	4mm	5W DC	Internal / Profile required
AQS-173	Cob Strip	IP20	RGBW	12mm	16W DC	Internal / Profile required
AQS-400	Neon Flex	IP65	Mono	9 x 10	5W / 10W DC	External / No profile required
AQS-401	Neon Flex	IP65	Mono	10 x 10	5W / 10W DC	External / No profile required
AQS-402	Neon Flex	IP65	Mono / RGB	6 x 12	5W / 10W DC	External / No profile required
AQS-410	Neon Flex	IP65	RGB	13 x 12	10W DC	External / No profile required
AQS-420	Neon Flex	IP65	Mono / RGBW	12 x 20	10W / 15W	External / No profile required
AQS-500	Neon Flex	IP68	Mono / RGB / RGBW / DMX	11.5 x 21	(Mono 5W / 8W / 12W) / 12W / 17W / 18W	External / Submerged / No profile
AQS-505	Neon Flex	IP68	Mono	13.5 x 13.5	10W	External / Submerged / No profile
AQS-510	Neon Flex	IP68	Mono / RGB / RGBW / DMX	16.5 x 16.5	10W / 13W / 17W / 18W	External / Submerged / No profile

Extension Wire Recommendations

Maximum extension wire length according to light power

Watts	22AWG 0.34mm ²	20AWG 0.53mm ²	18AWG 0.82mm ²	17AWG 1.04mm ²	16AWG 1.38mm ²	14AWG 2.07mm ²	12AWG 3.29mm ²	10AWG 5.62mm ²
10W	36m	60m	100m	120m	140m	240m	400m	600m
20W	18m	30m	50m	60m	70m	120m	200m	300m
30W	12m	20m	30m	38m	45m	80m	130m	200m
40W	8m	15m	22m	28m	35m	60m	95m	140m
50W	6m	12m	18m	22m	28m	48m	75m	105m
60W	5m	10m	15m	18m	22m	36m	60m	88m
70W	-	8m	12m	14m	18m	30m	50m	72m
80W	-	6m	10m	11m	14m	24m	40m	58m
90W	-	4m	7m	8m	10m	18m	30m	45m
100W	-	-	5m	6m	7m	12m	22m	32m
110W	-	-	3m	4m	5m	8m	15m	22m
120W	-	-	2m	2.5m	3m	0m	8m	12m