

Aqualux Casambi Dimmer Installation and Configuration Guide

MAY 2025

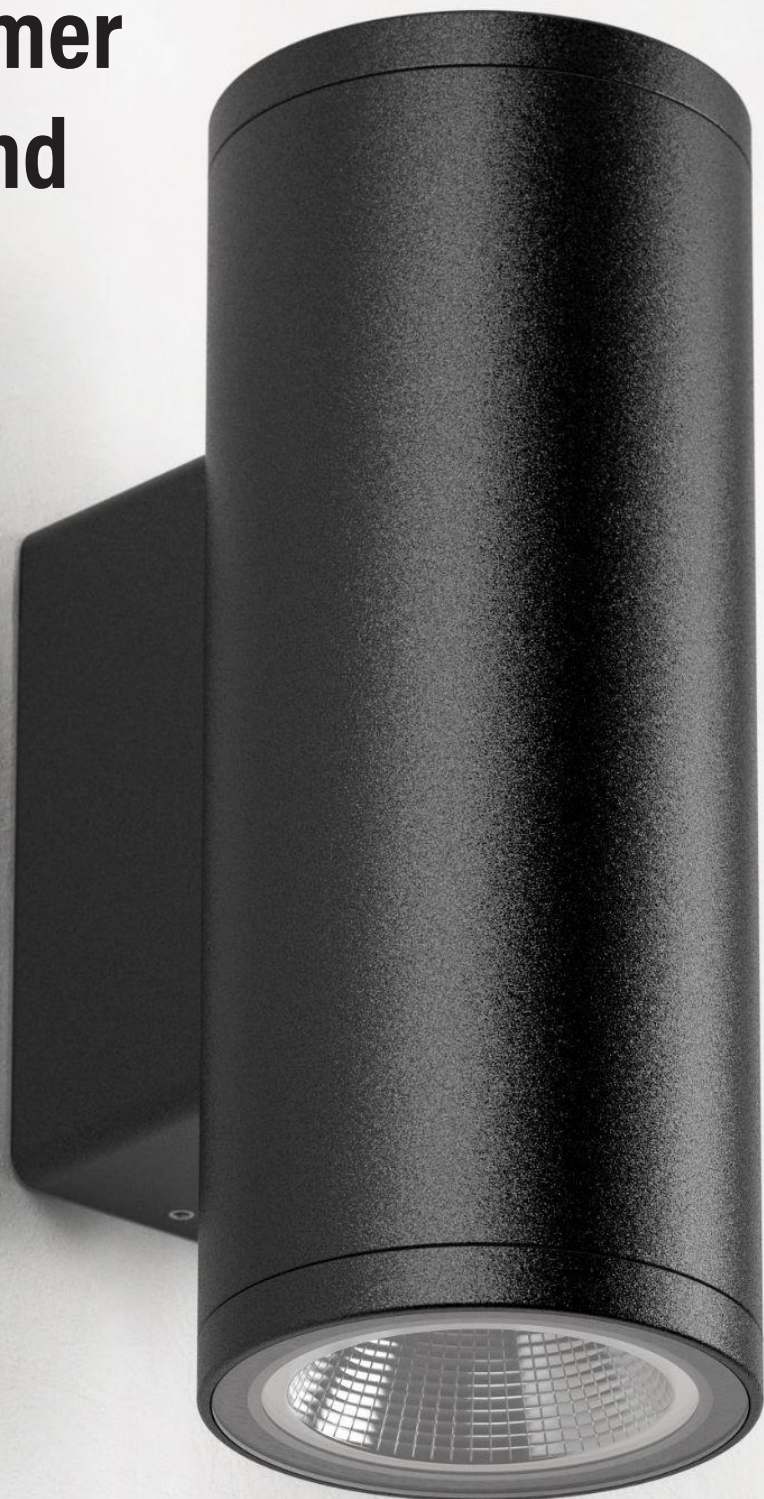

CONTENTS

02 **Table of Contents**

Technical Note

03 **I. Quick Test for Dimming**

05 **II. Installation Environment**

- A. Wiring Diagram
- B. Software

06 **III. Installation Instructions**

- A. TRIDONIC basicDIM Wireless G2
- B. TRIDONIC basicDIM Wireless SR
- C. CASAMBI CBU-ASD-LR
- D. CASAMBI CBU-A2D

14 **IV. Additional Notes**

- A. Firmware Updates

Technical Note

This document details steps to setup & configure Aqualux 3-Wire dimming lights with Casambi control gear.

It shows options for 4 different Casambi-DALI interface units.

Note that Aqualux does not recommend using the basicDIM Wireless G2 if aiming for a linear dimming curve.

The best dimming performance will be seen using one of the other Casambi-DALI interface modules.

I. Quick Test for Dimming

- 3-wire Aqualux products come with three color-coded wires (Fig. 1):

Red wire: Connect to the **positive terminal** of your 24V DC power supply.

White wire: Connect to the **negative terminal** of your 24V DC power supply.

Green wire: This is your **dimming control wire**. Connect it to your **CH terminal** in the LT-84A (Fig. 2).

For Aqualux products with **terminal blocks**, align the corresponding connections with the red, white, and green wire labels provided (Fig. 3).

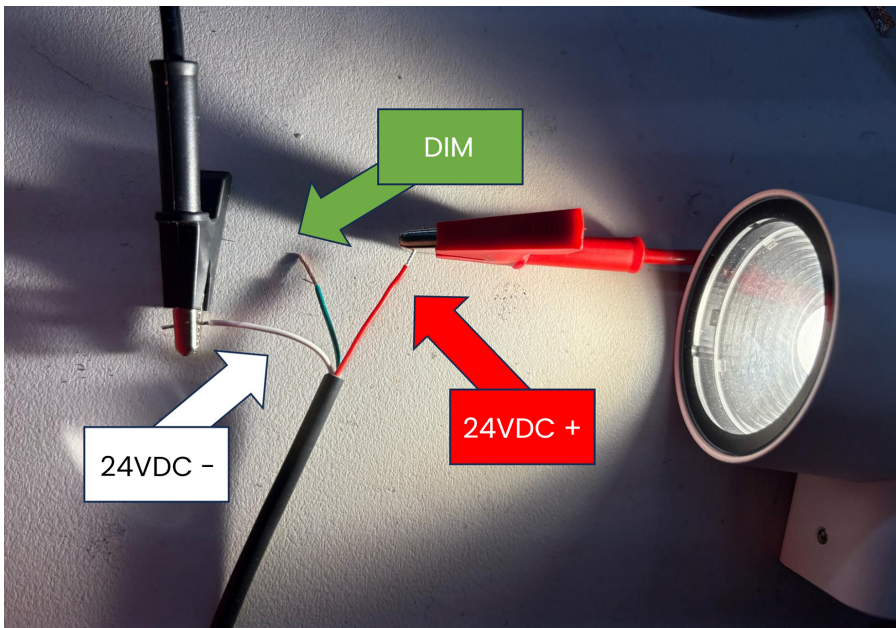

FIG. 1

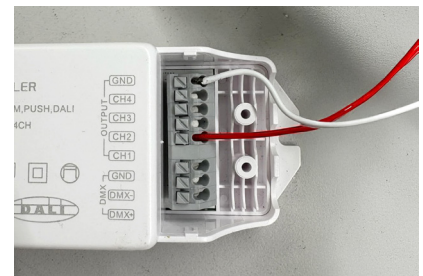

FIG. 2



FIG. 3

- Begin your dimming test by connecting only the **red** and **white** wires to the power supply, delivering **24V DC** to the AQL product. Leave the **dim wire disconnected** (floating). When properly connected, the AQL product will illuminate at **100% brightness** (Fig. 4). This confirms proper power connection.

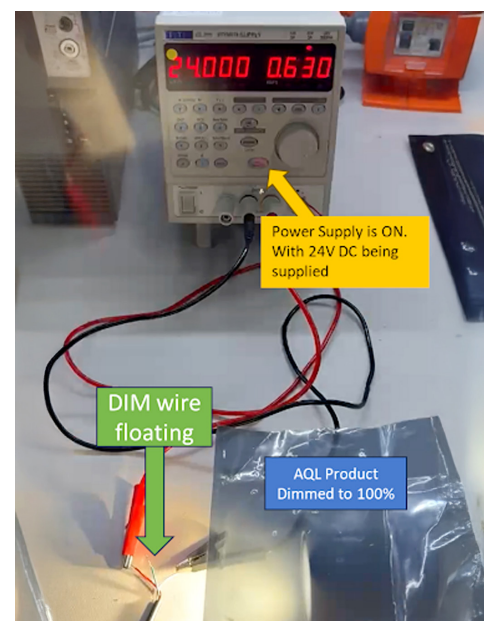

FIG. 4

3. After confirming the AQL product illuminates with the dim wire floating, test the dimming function by **connecting** (shorting) the **dim wire to the white wire** or 24V negative. This connection should reduce brightness to 0% (Fig. 5), confirming proper dimming function.
4. Verify complete dimming functionality by alternating the dim wire between **floating** (disconnected) and **shorted** to 24V negative. The AQL product should visibly toggle between **100% brightness** and **0% brightness** with each change. This step ensures the dimming circuit functions across its full range.
5. After successfully completing the dimming test, **power off** the 24V DC power supply completely. Now connect the dim wire to your desired **CH terminal** on the LT-84A. The LT-84A must remain **unpowered** during this connection to prevent circuit damage

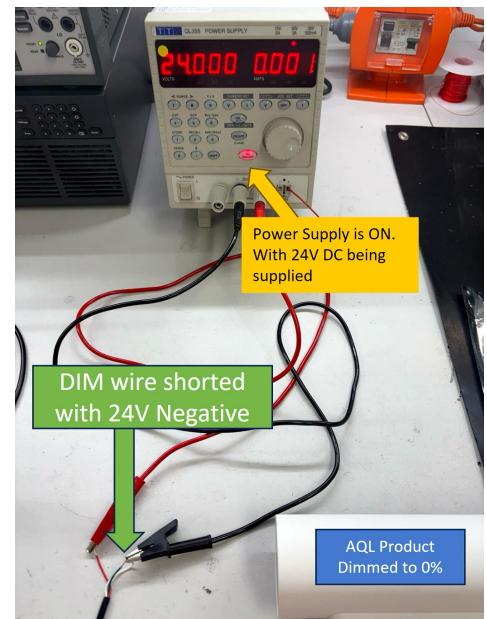

FIG. 5

II. Installation Environment

A. Wiring Diagram

B. Software

1. Access the official wiring diagram on Aqualux's website. Look for **Document #50** titled **"Mono 24VDC 3-Wire Casambi."** This document contains the authorized connection method for your product.
2. The diagram shows the WirelessG2 as an example dimmer. While other dimmers appear in the document, the connection principle remains the same for all models, allowing for standardized installation (Fig. 6).

1. This installation requires **Casambi's official mobile application**. Download and install the app shown (Fig. 7) before proceeding with any dimmer configuration.

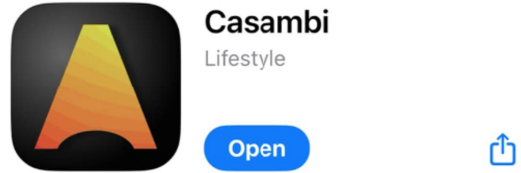

FIG. 7

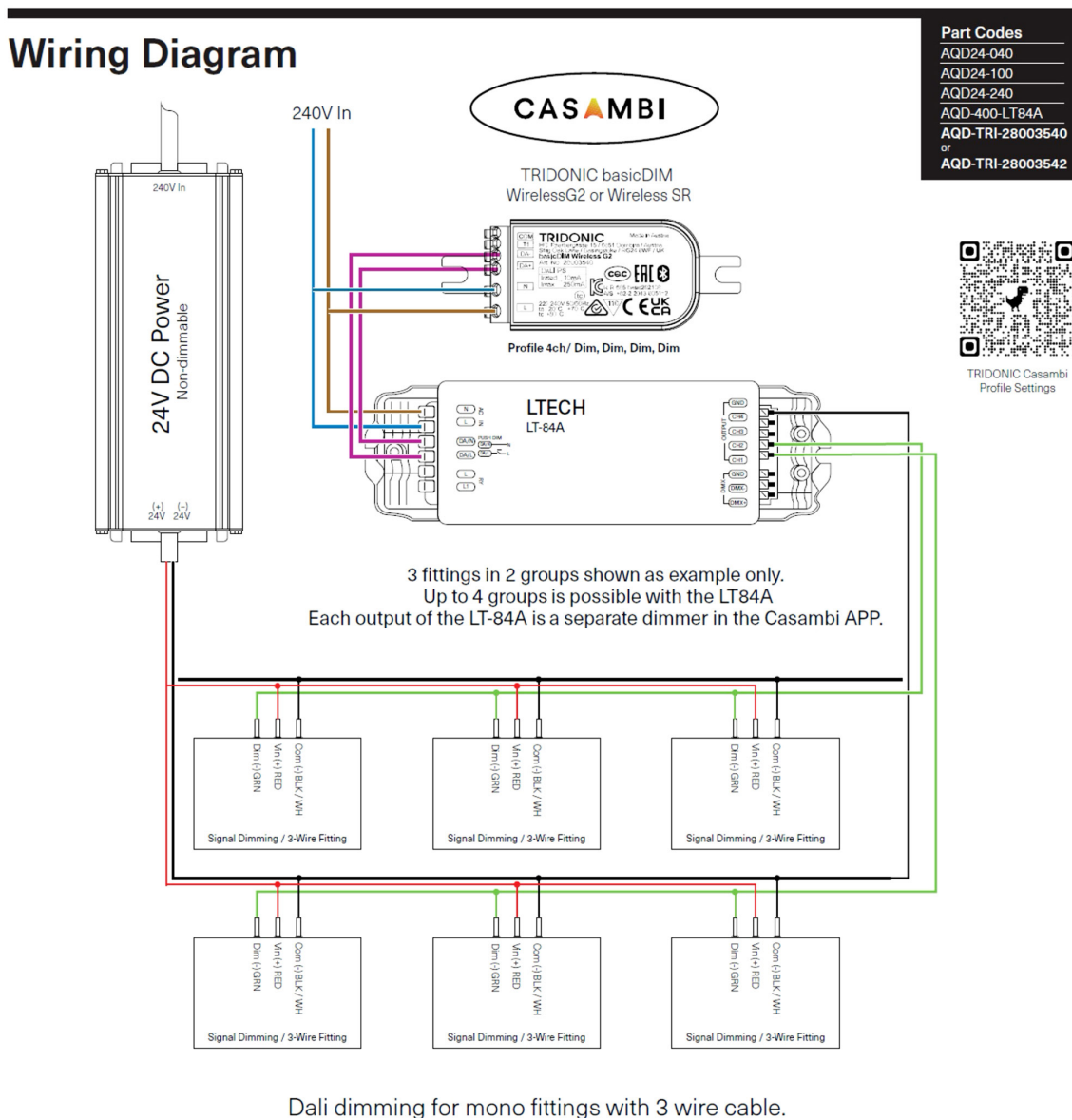

FIG. 6

III. Installation Instructions

A. TRIDONIC basicDIM Wireless G2

1. Verify your dimmer matches the **TRIDONIC basicDIM Wireless G2** shown (Fig. 8) before proceeding with installation.
2. After securing your wiring connections, apply **240V power** to the Casambi dimmer input.
3. Enable **Bluetooth** on the customer's mobile device to ensure proper communication with the dimmer.
4. Launch the Casambi app. The app will display **"Found a new device"** when it detects the G2 dimmer. Every Casambi dimmer requires assignment to a network. From the notification screen (Fig. 9), choose either **"Add to..."** (for existing networks) or **"Add individually to..."** (to create a new separate network) based on the customer's requirements.
5. In this installation example, we've added the dimmer to an existing network named "Aqualux 2024" (Fig. 10).
6. After network selection, the app integrates the new dimmer and displays all existing dimmers in the network. The control interface for luminaires appears with a yellow arrow indicating successful dimmer addition (Fig. 11).
7. The LT-84A controller requires the specific profile **"bDW (1pB - 4ch/Dim, Dim, Dim, Dim)"**. Follow Steps 9-13 to set this profile. If the unit already has this exact profile configured, proceed directly to Step 14.
8. Access the profile settings by pressing **"Edit"** in the top right corner, then select the Casambi G2's icon. The example shows the dimmer currently using the incorrect "bDW (1pB - 1ch/Dim)" profile (Fig. 12).
9. After selecting the G2's icon, the app displays detailed information about the device (Fig. 13).
10. Tap **"Model"** and select **"Change profile"** (Fig. 14) to access profile options.
11. The app presents all available profiles. Locate and select **"bDW (1pB - 4ch/Dim, Dim, Dim, Dim)"** from the list (Fig. 15) to enable multi-channel control.
12. Initiate the profile update by tapping **"Start update"** (Fig. 16) and wait for the update to complete.
13. The app returns to the Edit screen after updating. Verify the G2 now displays the correct profile (Fig. 17), then press **"Done"** to save changes.
14. The G2 dimmer is now operational. **Tap** the G2's icon in the luminaires tab to toggle lights on and off. For brightness adjustment, **press and hold** the icon until slider bars appear, allowing independent control of each LT-84A channel (Fig. 18).



FIG. 8

- The performance graph (Fig. 19) shows the expected dimming response curve. This measurement was taken using five 20W AQL-882 fixtures (100W total) and represents typical performance. Note: Aqualux does not recommend using the basicDIM Wireless G2 if aiming for a linear dimming curve.

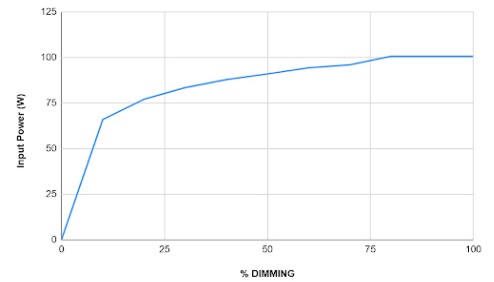

FIG. 19

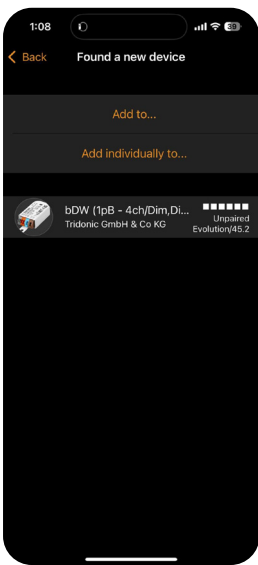

FIG. 9

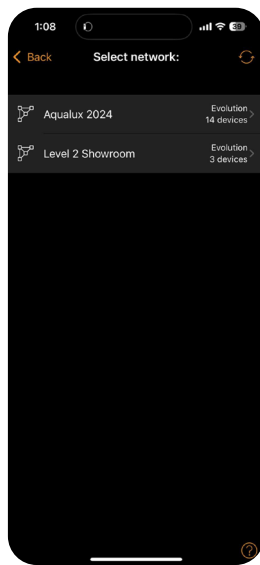

FIG. 10

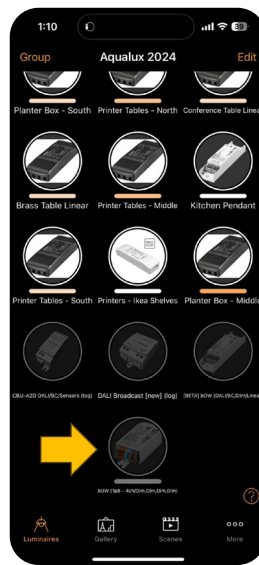

FIG. 11

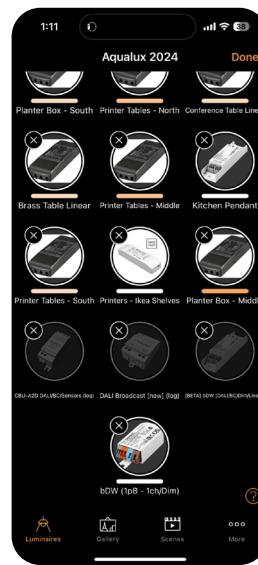

FIG. 12

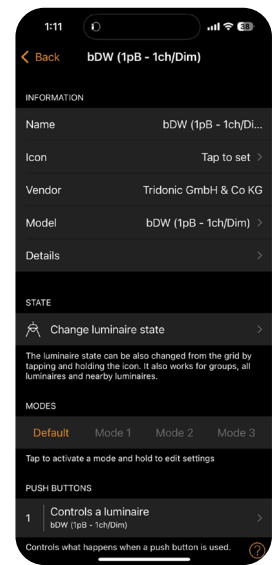

FIG. 13

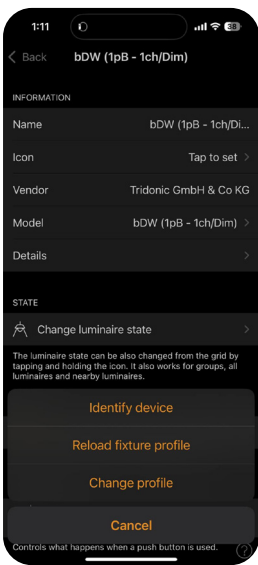

FIG. 14



FIG. 15

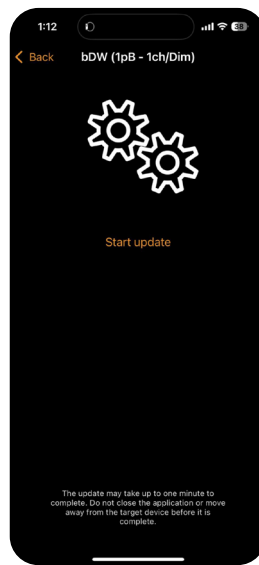

FIG. 16



FIG. 17

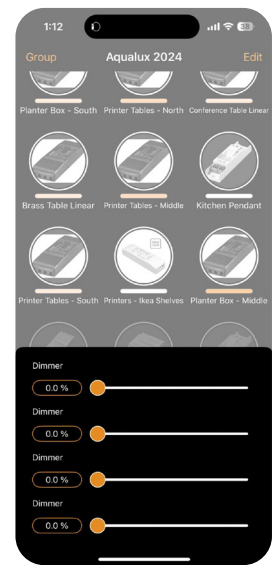

FIG. 18

B. TRIDONIC basicDIM Wireless SR

1. Verify your dimmer matches the **TRIDONIC basicDIM Wireless SR** shown (Fig. 20) before proceeding with installation.

2. After confirming your wiring connections are secure, apply **240V power** to the Casambi dimmer input.

3. Enable **Bluetooth** on the customer's mobile device to ensure proper communication with the dimmer.

4. Launch the Casambi app. The app will display a notification "**Found a new device**" when it detects the SR dimmer. Every Casambi dimmer requires assignment to a network. From the notification screen (Fig. 21), choose either "**Add to...**" (for existing networks) or "**Add individually to...**" (to create a new separate network) based on the customer's requirements

5. In this installation example, we've added the dimmer to an existing network named "Aqualux 2024" (Fig. 22).

6. After network selection, the app integrates the new dimmer and displays all existing dimmers in the network. The control interface for luminaires appears with a yellow arrow indicating successful dimmer addition (Fig. 23).

7. The LT-84A controller requires the specific profile "**bdim [BETA] bdw(DALI/BC/DIM/Linear)**". Follow Steps 9-13 to set this profile. If the unit already has this exact profile configured, proceed directly to Step 14.

8. Access the profile settings by pressing "**Edit**" in the top right corner, then select the Casambi basicDIM Wireless SR's icon. The example shows the dimmer currently using the incorrect "bdw (1pB - 1ch/Dim)" profile (Fig. 24).

9. After selecting the SR's icon, the app displays detailed information about the device (Fig. 25). Tap "**Model**" and select "**Change profile**" (Fig. 26) to access profile options.

10. The app presents all available profiles. Locate and select "**bdim [BETA] bdw(DALI/BC/DIM/Linear)**" from the list (Fig. 27) to enable proper control.

11. Initiate the profile update by tapping "**Start update**" (Fig. 28) and wait for the update to complete.

12. The app returns to the Edit screen after updating. Verify the SR now displays the correct profile (Fig. 29), then press "**Done**" to save changes.

13. The SR dimmer is now operational. **Tap** the SR's icon in the luminaires tab to toggle lights on and off. For brightness adjustment, **press and hold** the icon until slider bars appear, allowing control of all LT-84A channels (Fig. 30).

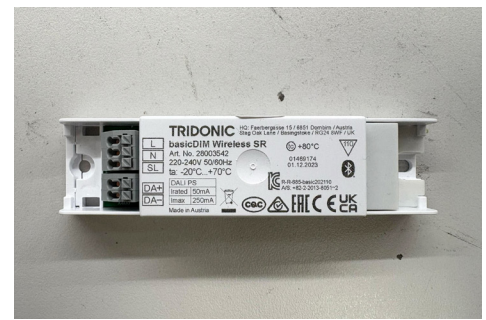

FIG. 20

14. The performance graph (Fig. 31) shows the expected dimming response curve. This measurement was taken using five 20W AQL-882 fixtures (100W total) and represents typical performance.

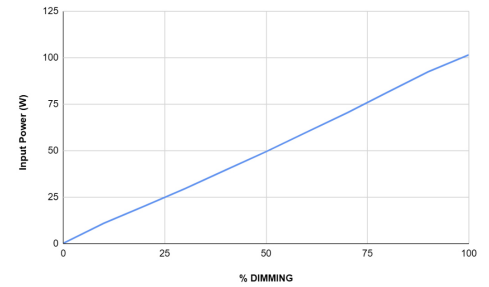

FIG. 31

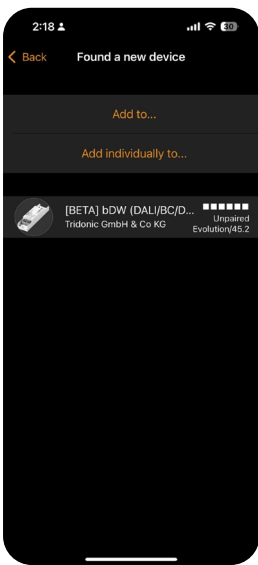

FIG. 21

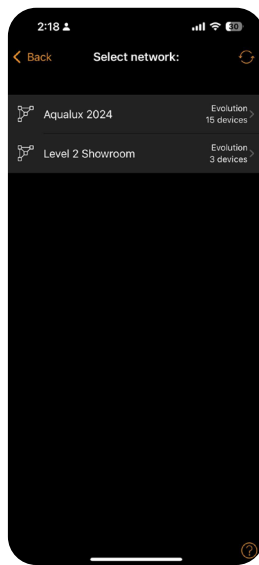

FIG. 22



FIG. 23



FIG. 24

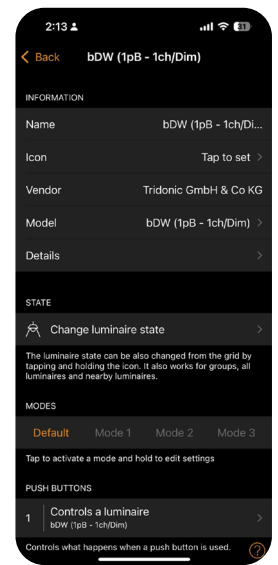

FIG. 25

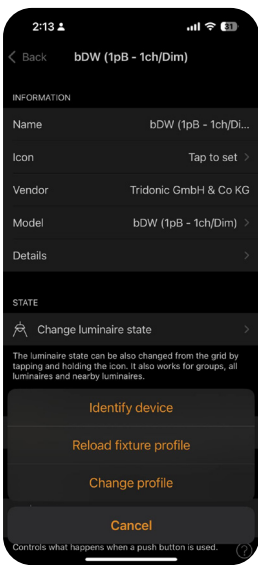

FIG. 26

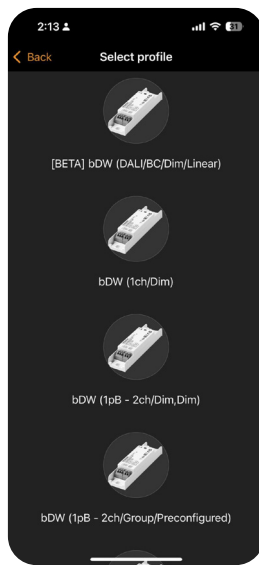

FIG. 27

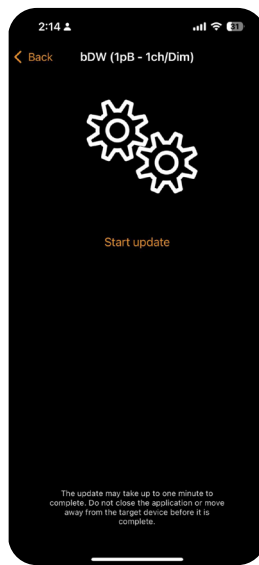

FIG. 28

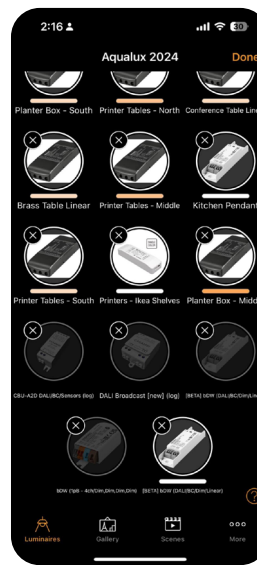

FIG. 29

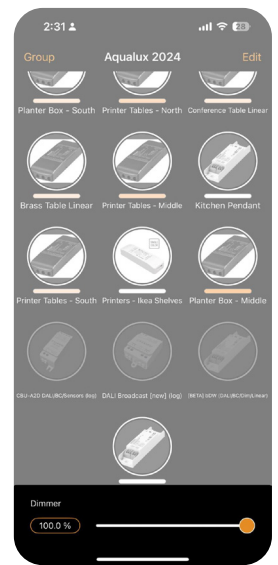

FIG. 30

C. CASAMBI CBU-ASD-LR

1. Verify your dimmer matches the **CASAMBI CBU-ASD-LR** shown (Fig. 32) before proceeding with installation.

2. After confirming your wiring connections are secure, apply **240V power** to the Casambi dimmer input.

3. Enable **Bluetooth** on the customer's mobile device to ensure proper communication with the dimmer.

4. Launch the Casambi app. The app will display a notification "**Found a new device**" when it detects the CBU-ASD-LR dimmer (Fig. 33).



FIG. 32

5. Every Casambi dimmer requires assignment to a network. From the notification screen (Fig. 34), choose either "**Add to...**" (for existing networks) or "**Add individually to...**" (to create a new separate network) based on the customer's requirements.

6. In this installation example, we've added the CBU-ASD-LR to an existing network named "Aqualux 2024" (Fig. 34).

7. After network selection, the app integrates the new dimmer and displays all existing dimmers in the network. The control interface for luminaires appears with a yellow arrow indicating successful dimmer addition (Fig. 35).

8. The LT-84A controller works with any of these three profiles, each offering different control options:

1. **DALI 4xDIM:** Enables individual control of each LT-84A channel.
2. **DALI 4xDIM [new]:** Enables individual control of each LT-84A channel with updated features.
3. **DALI Broadcast:** Sends a universal signal to control all LT-84A channels simultaneously.

9. Access the profile settings by pressing "**Edit**" in the top right corner, then select the CBU-ASD-LR's icon. The example shows the dimmer currently using the incorrect "DALI DT8 RGB/White" profile (Fig. 36).

10. After selecting the CBU-ASD-LR's icon, the app displays detailed information about the device (Fig. 37). Tap "**Model**" and select "**Change profile**" (Fig. 38) to access profile options.

11. The app presents all available profiles. Select the profile that best suits your specific application needs (Fig. 39) based on whether you need individual or unified channel control.

12. Initiate the profile update by tapping "**Start update**" (Fig. 40) and wait for the update to complete.

13. The app returns to the Edit screen after updating. Verify the CBU-ASD-LR now displays the correct profile (Fig. 41), then press "**Done**" to save changes.

14. The CBU-ASD-LR dimmer is now operational. **Tap** the CBU-ASD-LR's icon in the luminaires tab to toggle lights on and off. For brightness adjustment, **press and hold** the icon until control options appear. With DALI 4xDIM or DALI 4xDIM [new] profiles, multiple slider bars appear for individual channel control (Fig. 42). With DALI Broadcast [new] (lin) profile, a single slider controls all channels simultaneously (Fig. 43).

15. The performance graph (Fig. 44) shows the expected dimming response curve. This measurement was taken using five 20W AQL-882 fixtures (100W total) and represents typical performance.

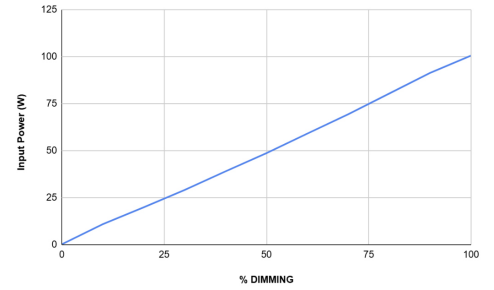

FIG. 44

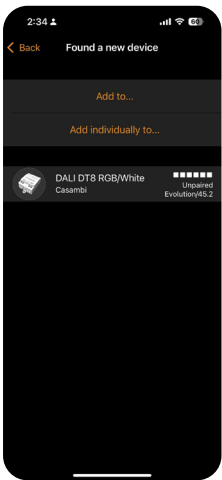

FIG. 33

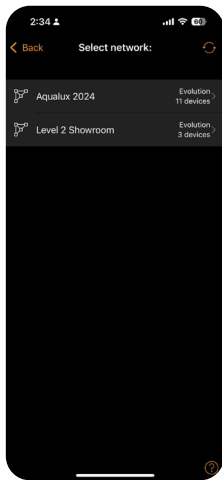

FIG. 34



FIG. 35



FIG. 36

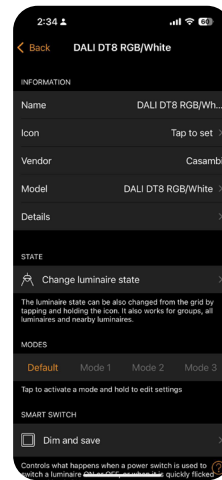

FIG. 37

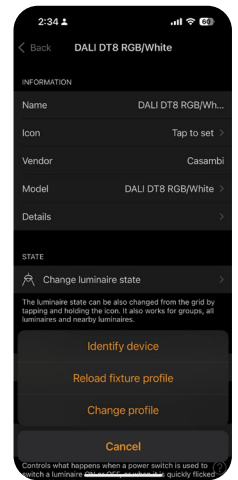

FIG. 38

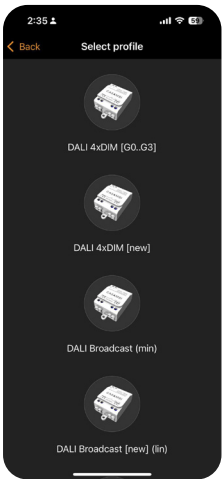

FIG. 39

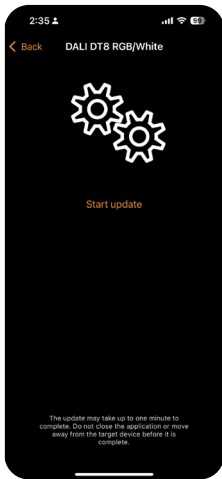

FIG. 40



FIG. 41

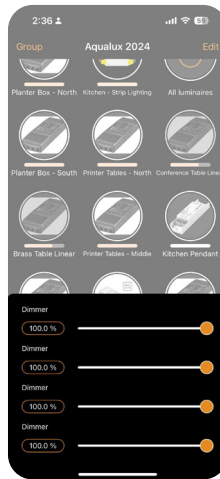

FIG. 42



FIG. 43

D. CASAMBI CBU-A2D

1. Verify your dimmer matches the CASAMBI CBU-A2D shown (Fig. 45) before proceeding with installation. For the CBU-A2D, connect the dimming wires specifically to CH1 on the upper right section of the LT-84A to ensure proper function.
2. After confirming your wiring connections are secure, apply **240V power** to the Casambi dimmer input.
3. Enable **Bluetooth** on the customer's mobile device to ensure proper communication with the dimmer.

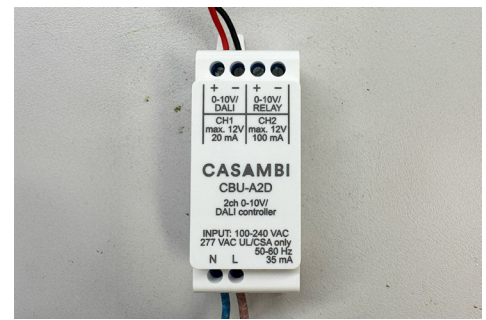

FIG. 45

4. Launch the Casambi app. The app will display a notification "**Found a new device**" when it detects the CBU-A2D dimmer. Every Casambi dimmer requires assignment to a network. From the notification screen (Fig. 46), choose either "**Add to...**" (for existing networks) or "**Add individually to...**" (to create a new separate network) based on the customer's requirements.
5. In this installation example, we've added the CBU-A2D to an existing network named "Aqualux 2024" (Fig. 47).
6. After network selection, the app integrates the new dimmer and displays all existing dimmers in the network. The control interface for luminaires appears with a yellow arrow indicating successful dimmer addition (Fig. 48).
7. The LT-84A controller works with either of these two profiles, each offering different control options:
 1. **CBU-A2D DALI 4CH:** Enables a individual control of each LT-84A channel separately.
 2. **CBU-A2D DALI/BC/Sensors (lin):** Sends a universal signal to control all LT-84A channels simultaneously.
8. Access the profile settings by pressing "Edit" in the top right corner, then select the CBU-A2D's icon. The example shows the dimmer currently using the incorrect "CBU-A2D DALI/BC/Sensors (log)" profile (Fig. 49).
9. After selecting the CBU-A2D's icon, the app displays detailed information about the device (Fig. 50). Tap "**Model**" and select "**Change profile**" (Fig. 51) to access profile options.
10. The app presents all available profiles. Select the profile that best suits your specific application needs (Fig. 52) based on whether you need individual or unified channel control.
11. Initiate the profile update by tapping "**Start update**" (Fig. 53) and wait for the update to complete.
12. The app returns to the Edit screen after updating. Verify the CBU-A2D now displays the correct profile (Fig. 54), then press "**Done**" to save changes.
13. The CBU-A2D dimmer is now operational. **Tap** the CBU-A2D's icon in the luminaires tab to toggle lights on and off. For brightness adjustment, **press and hold** the icon until control options appear. With CBU-A2D DALI 4CH profile, multiple slider bars appear for individual channel control (Fig. 55). With CBU-A2D DALI/BC/Sensors (lin) profile, a single slider controls all channels simultaneously (Fig. 56).

14. The performance graph (Fig. 57) shows the expected dimming response curve. This measurement was taken using five 20W AQL-882 fixtures (100W total) and represents typical performance.

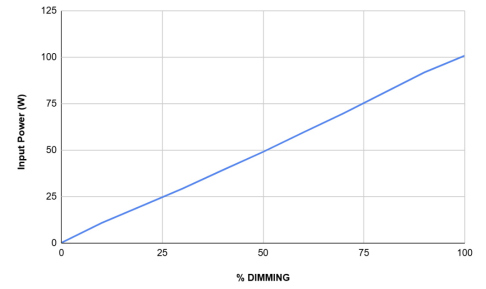

FIG. 57

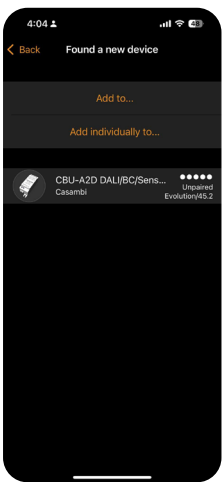

FIG. 46

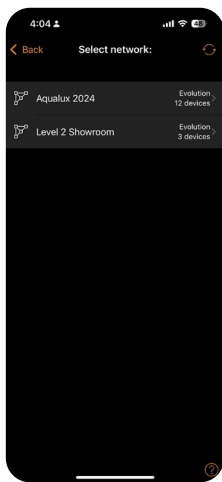

FIG. 47



FIG. 48



FIG. 49

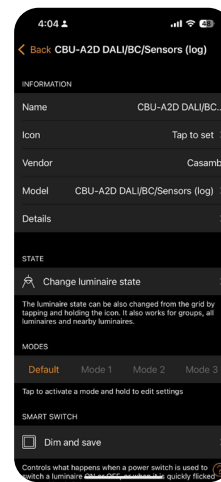

FIG. 50

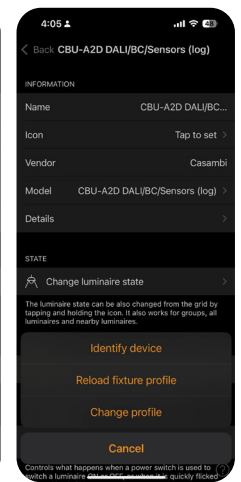

FIG. 51

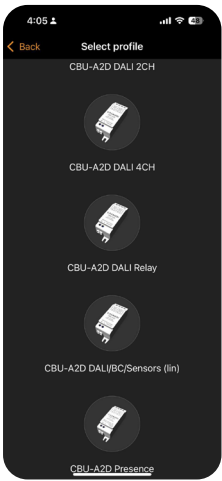

FIG. 52

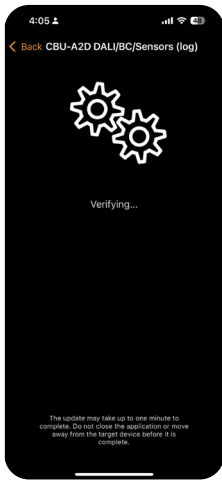

FIG. 53



FIG. 54

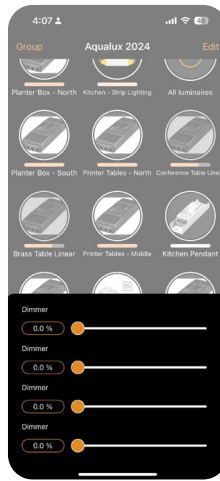

FIG. 55



FIG. 56

IV. Additional Notes

A. Firmware Updates

Maintaining current firmware ensures optimal performance and compatibility. The Casambi app automatically checks for firmware updates when adding new devices to your network. When updates are available, the app guides you through the **three-step update process** (Figs. 58-60).

Always complete firmware updates to access the latest features and ensure reliable operation.

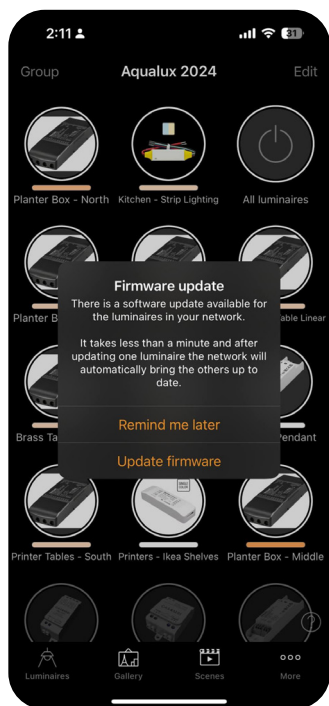

FIG. 58

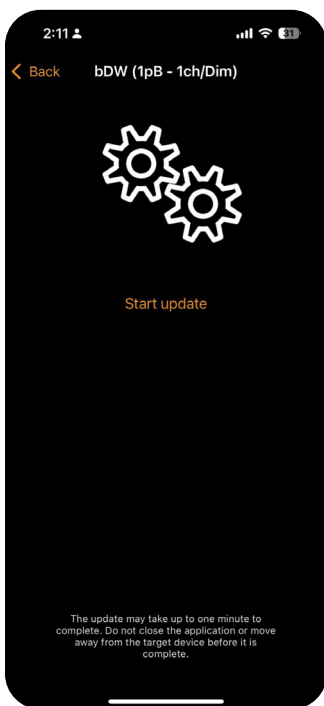

FIG. 59

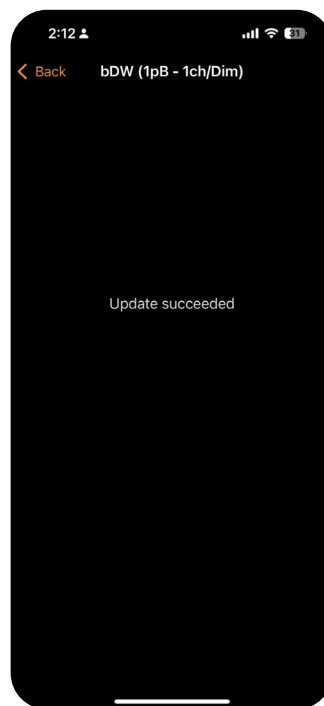

FIG. 60