

Turnable Linear

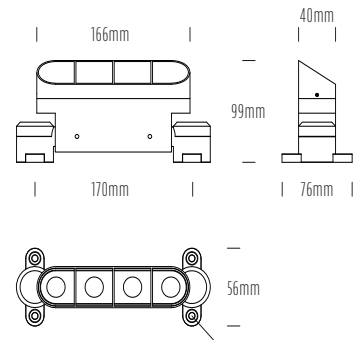

TECHNICAL	
PRODUCT CODE	AQL-652
BEAM ANGLE	10° / 15° / 30° / 10x50° / 20x40°
CONSTRUCTION	Machine Cut Aluminum 6063
CCT	2700K / 3000K / 4000K / 5000K
EFFICACY	78Lm/W / 82Lm/W / 93Lm/W / 103Lm/W
LUMEN OUTPUT	476Lm / 498Lm / 560Lm / 615Lm
WATTS	6W
LED SMD	Nichia / Osram
INPUT VOLTAGE	24V DC
MINIMUM RUN LENGTH	3 module (500mm)
MAXIMUM RUN LENGTH	18 module (3m)
INPUT / OUTPUT CABLES	200mm w/ IP68 Chogori connector
EXTENSION CABLES	2m & 10m Chogori extension cable options
DIMMING OPTIONS	0~10V / PWM / Dali / DMX
IP RATING	IP66
LIFETIME	60,000hrs - LM80
WARRANTY	5 Year Aqualux Warranty

CONFIGURE	
BODY COLOUR	Powder coated Black - RAL 9011 Powder coated White - RAL 9001 Powder coated Grey - RAL 9006



1300 662 644
sales@aqualux.com.au

Visit www.aqualux.com.au for: Full product details and available options. Order code configuration & customised datasheets. Voltage drop calculator & LED technical information.